

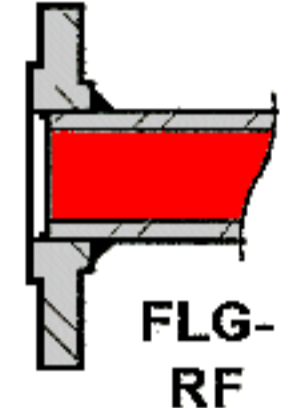

WAG-WAVEGUARD- SP SPHERICAL

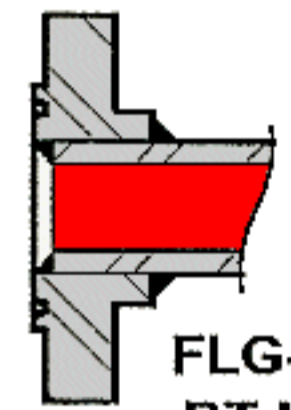

**TRUE THRU-FLOW IN-LINE TWIN CONNECTIONS
NO MOVING PARTS - NO N2 PRE-FILL - NO ELASTOMERS**

'e' Nbr.	Nominal Volume.		Working Press.*		Vessel Diam.		Radius R		Weight Est.		Price \$
	Gls.	Ltrs.	Psi.	Bar.	ins.	mm	ins.	mm	lbs.	Kg.	
316 STAINLESS STEEL											
99	43		3220		30		21		1110		11,190
99		165		222		756		533		505	
132	58		3280		33		22		1500		15,081
132		220		226		834		558		683	
149	66		3240		34		23		1680		17,310
149		250		224		868		584		764	
205	89		3320		38		26		2340		37,082
205		340		229		966		660		1063	
576	250		3130		54		39		6030		39,251
576		950		216		1352		990		2742	
UNS 1.0566 Carbon Steel											
424	184		4060		50		37		5800		30,261
424		700		280		1254		940		2640	

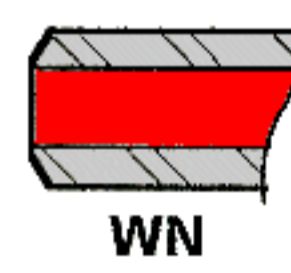
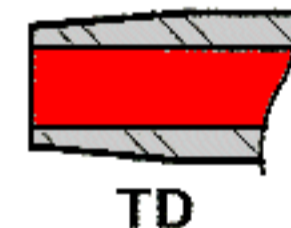
- Connection Options
- FLANGED
 
 FLG-RF
 - FLANGED
 
 FLG-RTJ
 - HUB
 
 HB
 - WELDED
 
 WN
 - THREADED
 
 TD

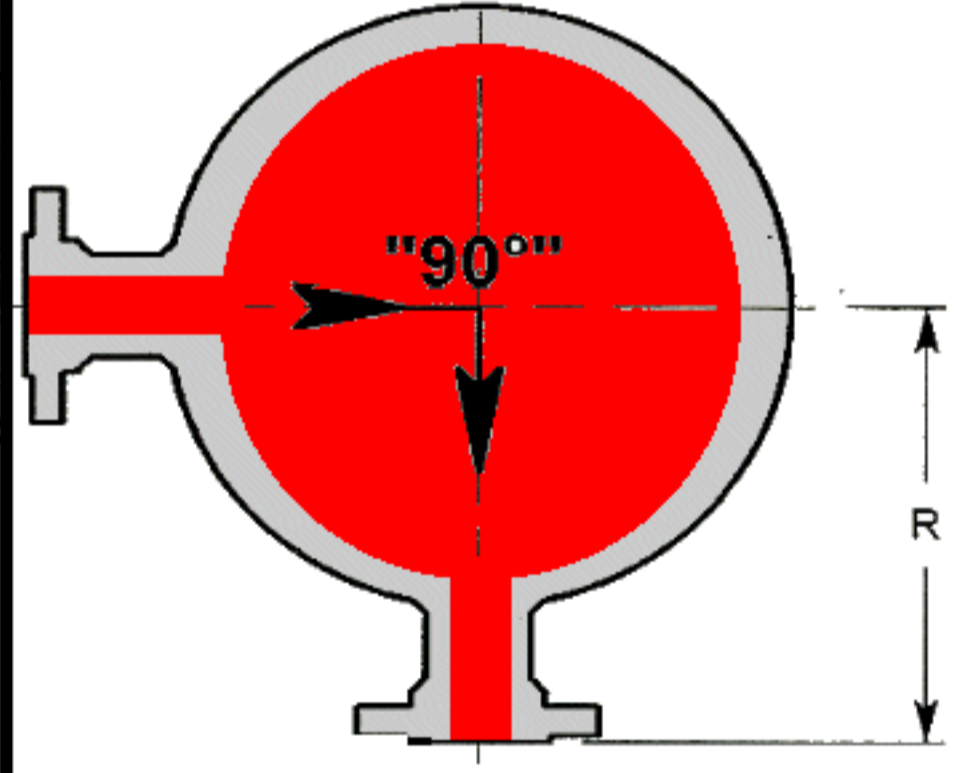
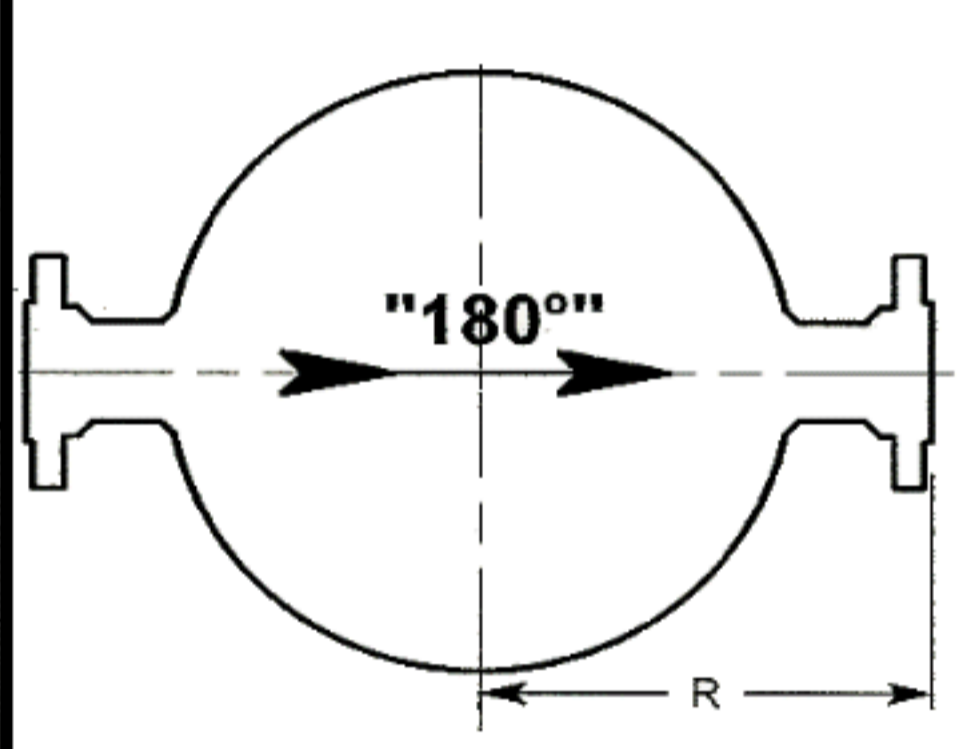
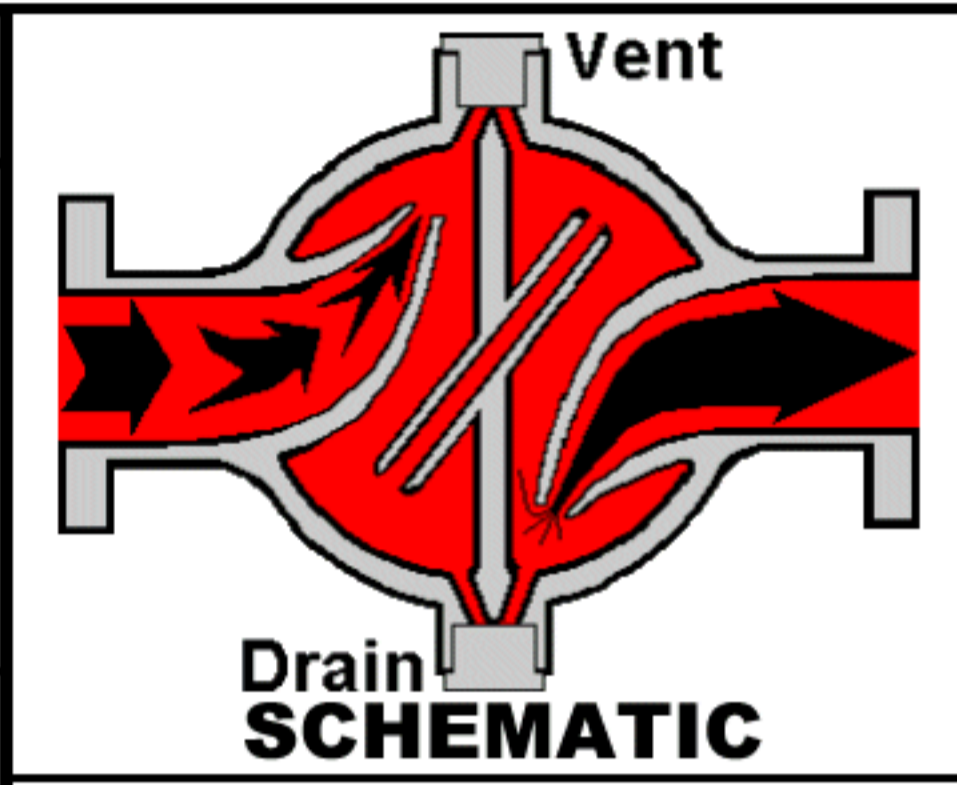

NOTES:

* Based on Weld Joint
Factor = 1.0

Item	Part No.	Description	Material	I.D. #
4				
3		Connection End		
2		Connection		
1		Sphere		

CUSTOMER:

CUSTOMER REF:

QUANTITY:

W/O No.:

ISSUED BY:

CHECKED BY:

ISSUE DATE: (DAY/MONTH/YEAR)

FILE REF: WaGsphVW.bmp

SCALE: NTS | ALL DIMENSIONS ARE IN MM EXCEPT AS STATED.

VIEW NO. WaG-SPH/TW/FLG/
___Lt/___Br/SS/90ISC

SHEET: 1 OF 1 | REV.

ACCOUSTIC & BULK MODULUS COMPRESSION DAMPER

PULSEGUARD
In Assoc. with Liquid Dynamics
www.pulsation-shock.com
ISO 9001 VESSEL CODE # 28,289
BOX 506, HAMPSTEAD, N.C. 28443, USA.
Tel: 910-270-2737. Fax: 270-2739
P.O. BOX 47, STOCKPORT, UK, SK5 7BB.
Tel: 0161-442-6222. Fax: 443-1466

**PULSATION DE-COUPLER/
INTERCEPTOR**

**Prevent System Response Pulsations
from Amplifying and Resonating with
the Forcing Frequency.**